

RoHS+HF

REV	DESCRIPTION	DESIGN	DATE
A	NEW RELEASE		2024/04/01

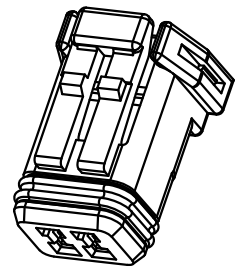
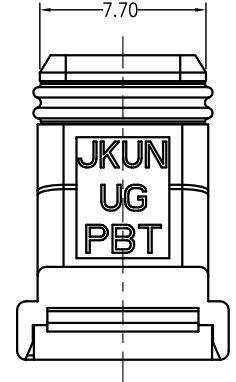
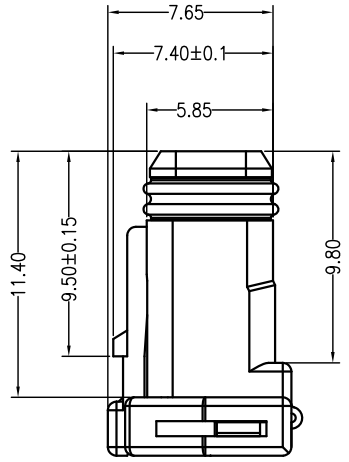
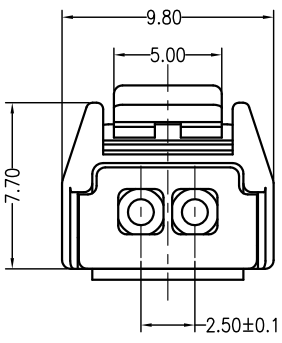
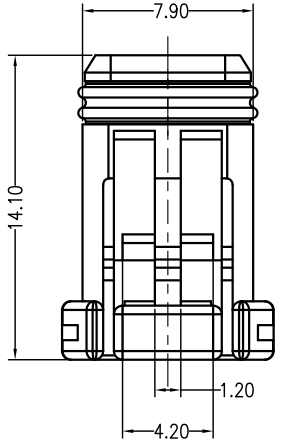
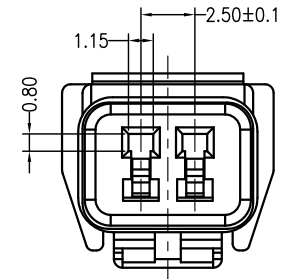

Specifications:

- Contact resistance: $\leq 30m\Omega$
- Insulation resistance: $\geq 100M\Omega$
- Rated voltage: 250VAC/50VDC
- Rated current: 5.0A
- Withstand Voltage: 1000V AC/minute
- Temperature Range: $-40^{\circ}C \sim +105^{\circ}C$
- Housing: PBT Grey
- Waterproof ring: silicon rubber
- Protection level: IP67

ORDER INFORMATION:

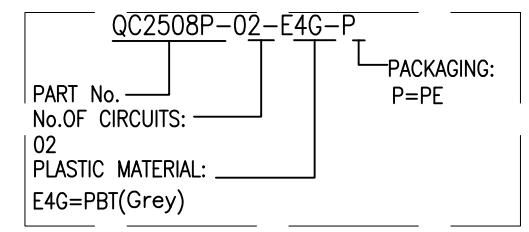

JKUN 温州健坤接插件有限公司 WENZHOU JKUN CONNECTOR CO.,LTD.		TITLE: QC2508P	
GENERAL TOLERANCE		USE: CUSTOMER	PART NO.:
X.X ±0.30	X. ±5'	APPD: Yaojianjun	QC2508P-02-E4G-P
X.XX ±0.20	X.X ±2'	CHKD: Yanpeng	DWG NO.:
X.XXX ±0.10	X.XX ±1'	DR: Chengyonghai	JKUN-GCKH
⊕	UNITS: mm	SCALE: 1 : 1	SHEET: 1 / 1